



1000 Base Single Port Transformer

P/N: G2406SG



Feature

- Designed to meet IEEE802.3ab (Long Haul Gigabit) requirement.
- Operating temperature range from 0°C to +70°C
- Storage temperature range from -25°C to +125°C

Specification

Electrical Specification @25°C					
Part Number	OCL(μ H min) @ 100KHz/0.2V With 8mA DC Bias	Turn Ratio ($\pm 3\%$)	Cross Talk (dB min)		Hi-Pot (Vrms)
			0.5-40MHz	40.1-100MHz	
G2406SG	350	1CT:1CT	35	33-20log(f/50)	1500

Electrical Specification @25°C				
Part Number	Insertion Loss (dB max)	Return Loss (dB min)		CMRR (dB min)
	0.5-100MHz	0.5-40MHz	40.1-100MHz	0.5-100MHz
G2406SG	1.1	18	12-20log(f/80)	30

Schematic

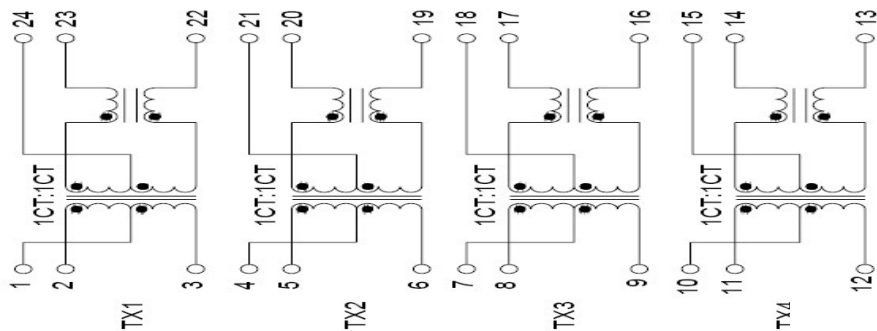

Mechanical

