



10 / 100Base Single Port Transformer

P/N: H1609SG



Feature

- Designed to meet IEEE802.3 and ANSIX3.263 requirement.
- Primary inductance 350uH min. with 8mA DC Bias
- Operating temperature range from 0°C to +70°C
- Storage temperature range from -25°C to +125°C

Specification

Electrical Specification @25°C						
Part Number	OCL(uH min) @ 100KHz/0.2V	Turn Ratio (±3%)		Cross Talk (dB min)		Hi-Pot (Vrms)
	With 8mA DC Bias	TX	RX	0.5-40MHz	40.1-100MHz	
H1609SG	350	1CT:1CT	1CT:1CT	35	30-20log(f/50)	1500

Electrical Specification @25°C					
Part Number	Insertion Loss (dB max)	Return Loss (dB min)			CMRR (dB min)
	0.5-100MHz	0.5-30MHz	30.1-60MHz	60.1-80MHz	0.5-100MHz
H1609SG	1.1	18	18-20log(f/30)	12	30

Schematic

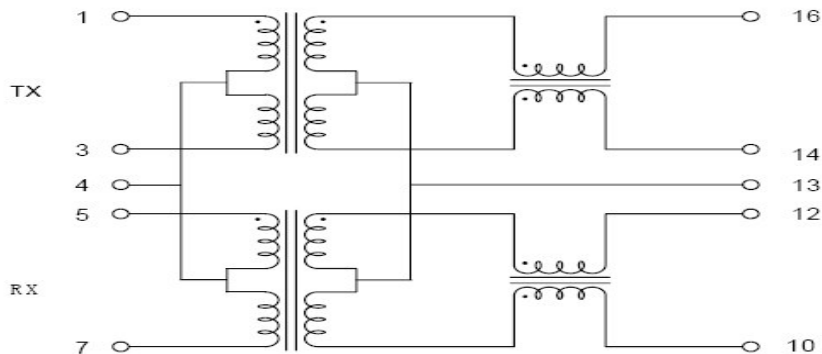

Mechanical

